

STELLA IP67 DOWNLIGHT

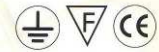

A high quality IP67 rated recessed downlight for exterior applications. Die-cast aluminium housing and bezel, phospho-chromatised and powder coated for added protection and supplied complete with toughened safety glass. Compact fluorescent versions supplied complete with integral control gear, CDM-T versions can be specified with conventional or electronic remote IP rated gear (to be ordered separately). Bezel available in white, black or silver as standard with other colours to order.

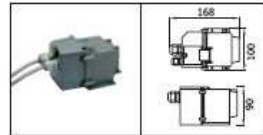

38
BALLAST HIT 35W IP 67

39
BALLAST HIT 70W IP 67

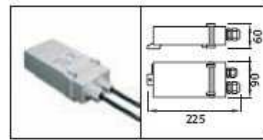

83
ELECTRONIC BALLAST HIT 35W IP 66

84
ELECTRONIC BALLAST HIT 70W IP 66

600913
TC-D 26W G24 d-3

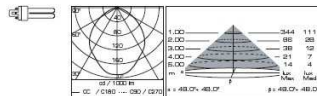

602113
TC-TEL 42W Gx24 q-4
Electronic ballast

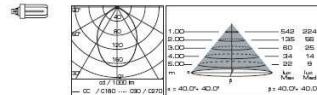

603513
HIT 35W G12
Remote ballast to be ordered

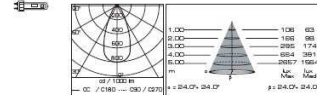

607113
HIT 70W G12
Remote ballast to be ordered

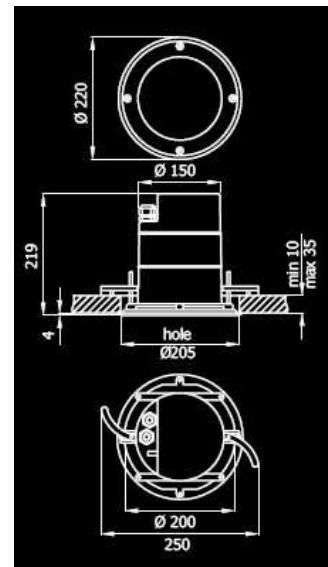
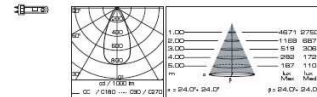

Recessed IP67 Downlight

Cat.No	Lamp Type	Wattage
600913	TC-D	26W
602113	TC-TE	42W
603513	CDM-T	35W
607113	CDM-T	70W

- 38 Remote IP67 35W Gear
- 39 Remote IP67 70W Gear
- 83 Remote IP66 Electronic 35W Gear
- 84 Remote IP66 Electronic 70W Gear

Other sizes and lamp types available
Stainless Bezel versions available

For further information:-
http://www.aresill.net/downloads/catalogues/ARES_stella_catalogue.pdf