



Willy Meyer+Sohn GmbH+Co. KG
Stemmessiepener Weg 5
D-58675 Hemer
Telephone: +49 (0) 23 72/98 91-0
Telefax: +49 (0) 23 72/98 91-48
E-mail: info@meyer-lighting.com
www.meyer-lighting.com





Superlight Compact Nano

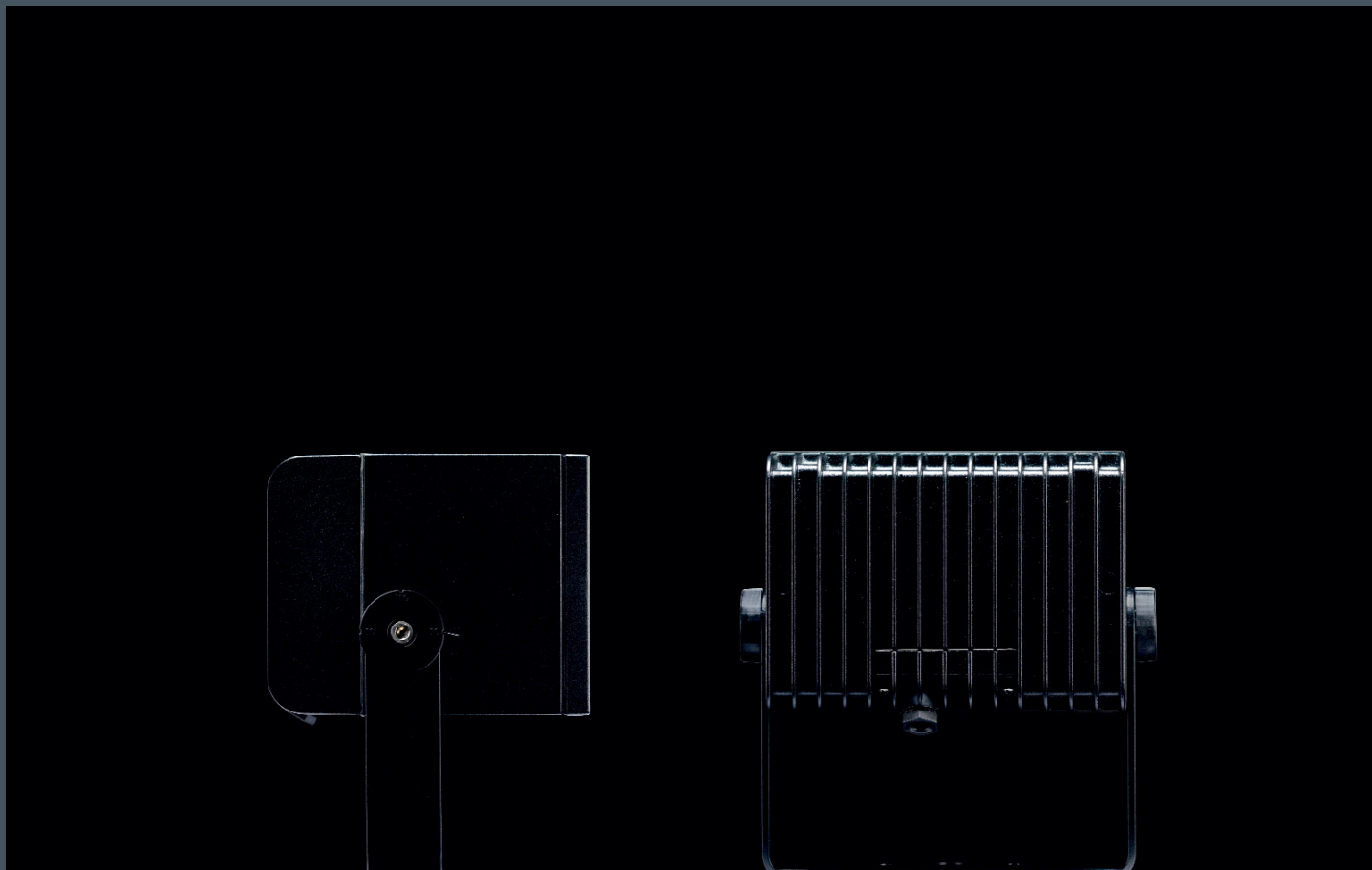

This year we look back on a successful product story – 25 years of Superlight Compact. At the beginning was the idea to have a versatile floodlight range in a neutral and timeless form. The result was a design that is reduced to its basic functional characteristics. Form follows Functionality, allowing buildings to take the stage at night.

Since 1986 Superlight Compact has set standards in design, compactness and quality. It is still today the most compact and efficient floodlight range for exterior applications. Highest levels of workmanship and the best materials ensure reliable operation, year after year.

The comprehensive range of accessories allows the floodlights to be adapted to individual lighting applications. Today that includes the patented accessory Light Lock which is designed to ensure that after relamping, the luminaires are returned to their original aiming angle.

Over the years, advances in lighting technology were incorporated into the on- going development of the Superlight Compact range. New and even smaller floodlights for miniature metal halide lamps were introduced. The latest product for LEDs, Superlight Compact Nano clearly follows this tradition. You can find out more about this new product overleaf.





Interview with Hermann Meyer and Klaus Storch, the creators of Superlight Compact.

Good products are geared to demand. What triggered the development of Superlight Compact?

Klaus Storch: Back then metal halide was the latest innovation in lamp technology. But the technical floodlights available on the market at that time were not exactly elegant! There was a place in the market for a product with a simple design which would blend into its surroundings discreetly.

So it was all about Simplicity and Neutrality. How was that incorporated in the product design?

Hermann Meyer: We wanted clear lines and nothing superfluous. Every detail should fulfil its purpose. Apart from that we also wanted a housing with flush surfaces.

So was it Design or Function that was in the foreground?

Klaus Storch: Definitely both and that was the challenge. Reflectors with various different light distributions had to be accommodated in a rectangular housing. And all of that in the smallest possible

space. It was not easy to protect the components from too much heat. But we managed.

Superlight Compact floodlights have been around for 25 years but the demand has not faded. What is the secret of success?

Hermann Meyer: The range is well known all over the world, its advantages too. It is the original and originals live longer.

There have always been Superlight Compacts for the latest in lamp technology. Where are you going from here?

Klaus Storch: The new miniature metal halide lamps made smaller housings a possibility. And of course we made good use of that fact. Now we offer even smaller products equipped with high performance LEDs. Superlight Compact Nano is the smallest LED floodlight with integral control gear.

Hermann Meyer: Everything gets better and smaller. Naturally our floodlights as well.

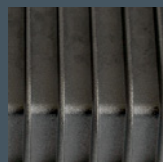

The housings are made of the most corrosion resistant, low copper aluminium alloy (EN AC AlSi12).

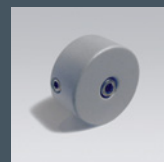

The patented Light Lock mechanism ensures that after maintenance, the luminaires are returned to their original aiming angle.



Superlight Compact Nano is the latest addition to the well established floodlight range offering a product with exceptionally small dimensions. It makes use of the new generation of high efficiency LEDs. With a choice of different light distributions, these luminaires are particularly useful for accent lighting on façades and for garden or landscape lighting. True to the concept of the Superlight Compact range, the control gear is integral. The result is an extremely compact floodlight for direct connection to the mains electricity supply.

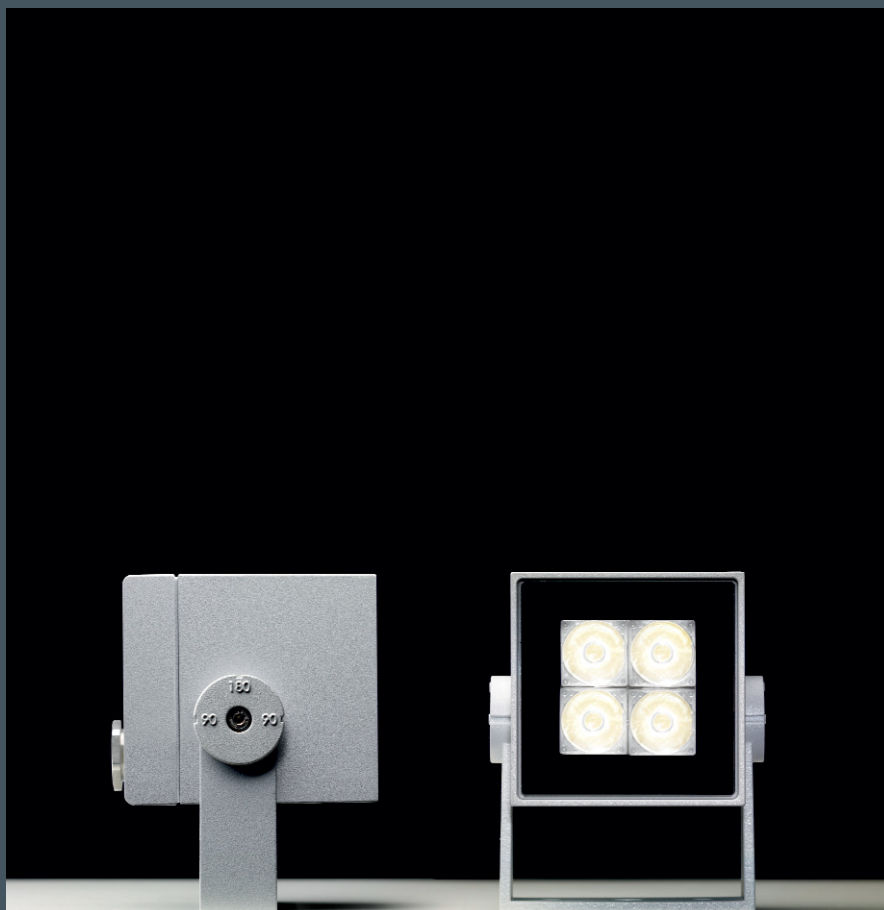

With integral control gear the floodlights can be connected directly to 120 – 240V 50/60Hz mains power supply. They offer high performance but are nevertheless very compact in size.



Thanks to their small dimensions, Superlight Compact Nano floodlights can be integrated discreetly in the architectural surroundings, e.g. for accent lighting of façades.

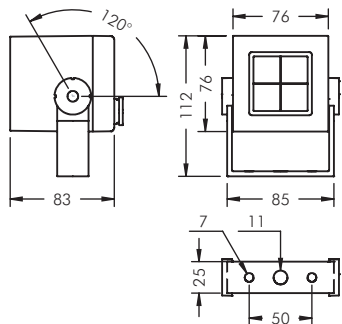

Superlight Compact Nano

Equipped with 4 x 1 W high performance LEDs, thermal monitoring device, protection class I, IP65 \diamond \triangle \triangle , IK08 die cast aluminium housing, polyester powder coated, all exterior steel parts are stainless steel, tempered safety glass, silicon gasket, powder coated die cast zinc mounting bracket with tilt scale: 2 drilled holes \varnothing 7 mm, spacing 50 mm, 1 centre hole \varnothing 11 mm, tilt range 120°, M20 cable gland, integral driver

Superlight Compact Nano, narrow beam

| Part number | Colour | Light source | Weight | Beam angle γ |
|----------------------|-------------|------------------------|--------|---------------------|
| 8 818 046 010 | black | 4 x LED 1 W warm white | 0,7 kg | 7° |
| 8 818 066 010 | white | | | |
| 8 818 056 010 | silver grey | | | |

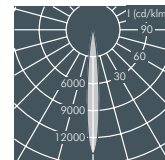
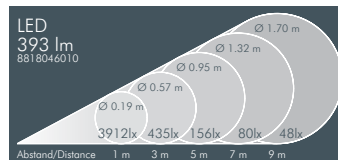

| Part number | Colour | Light source | Weight | Beam angle γ |
|----------------------|-------------|---------------------------|--------|---------------------|
| 8 818 045 010 | black | 4 x LED 1 W neutral white | 0,7 kg | 7° |
| 8 818 065 010 | white | | | |
| 8 818 055 010 | silver grey | | | |

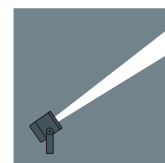

Superlight Compact Nano, linear beam spread, vertical

| Part number | Colour | Light source | Weight | Beam angle γ | |
|----------------------|-------------|------------------------|--------|---------------------|------------|
| | | | | C 0 - 180 | C 90 - 270 |
| 8 818 046 020 | black | 4 x LED 1 W warm white | 0,7 kg | 13° | 41° |
| 8 818 066 020 | white | | | | |
| 8 818 056 020 | silver grey | | | | |

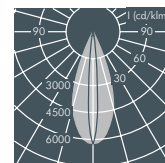
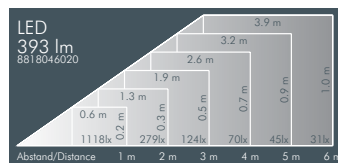

| Part number | Colour | Light source | Weight | Beam angle γ | |
|----------------------|-------------|---------------------------|--------|---------------------|------------|
| | | | | C 0 - 180 | C 90 - 270 |
| 8 818 045 020 | black | 4 x LED 1 W neutral white | 0,7 kg | 13° | 41° |
| 8 818 065 020 | white | | | | |
| 8 818 055 020 | silver grey | | | | |

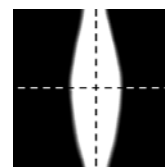
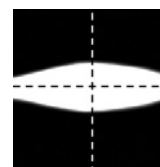

| Part number | Description |
|-------------------|--|
| 030 | Luminaire with linear beam spread, horizontal |

Superlight Compact Nano, wide beam

| Part number | Colour | Light source | Weight | Beam angle γ |
|----------------------|-------------|------------------------|--------|---------------------|
| 8 818 046 050 | black | 4 x LED 1 W warm white | 0,7 kg | 30° |
| 8 818 066 050 | white | | | |
| 8 818 056 050 | silver grey | | | |

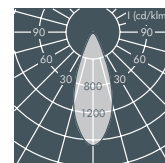
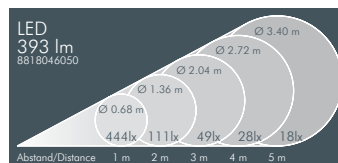

| Part number | Colour | Light source | Weight | Beam angle γ |
|----------------------|-------------|---------------------------|--------|---------------------|
| 8 818 045 050 | black | 4 x LED 1 W neutral white | 0,7 kg | 30° |
| 8 818 065 050 | white | | | |
| 8 818 055 050 | silver grey | | | |

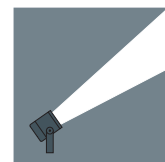

Light source

LEDs, replacement modules available



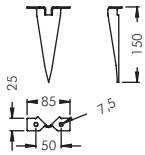

Accessories for Superlight Compact Micro

| Part number | Colour | Description |
|----------------------|-------------|---------------------------------------|
| 128 0 665 940 | black | Earth spike , stainless steel, |
| 128 0 665 960 | white | for use in landscaped areas |
| 128 0 665 950 | silver grey | |

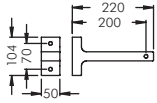

| Part number | Colour | Description |
|----------------------|-------------|--|
| 125 0 160 940 | black | Wall bracket 220mm , aluminium, polyester powder coated, |
| 125 0 160 960 | white | allows horizontal adjustment and directional aiming of luminaire |
| 125 0 160 950 | silver grey | |

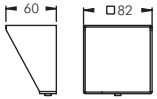

| Part number | Colour | Description |
|----------------------|-------------|-----------------------------------|
| 128 0 664 940 | black | Cowl, stainless steel , |
| 128 0 664 960 | white | to avoid glare from 3 directions, |
| 128 0 664 950 | silver grey | for retro-fitting |

